

SMB Bearings

Radial Ball Bearing

Part Number: SMR74ZZ



(for illustration only)

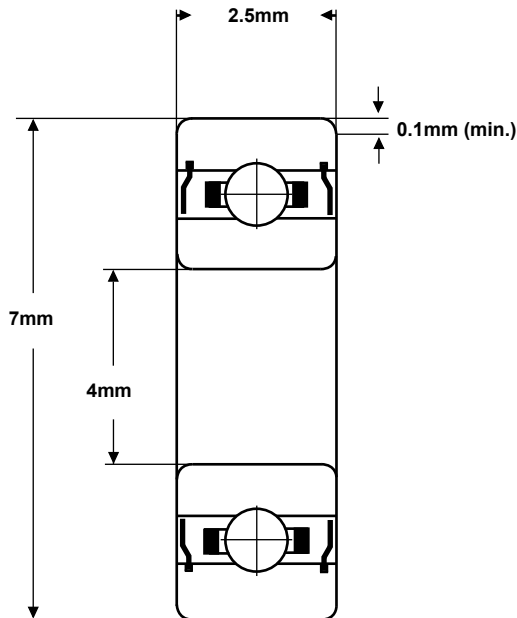

Material (rings & balls)	KS440 / AISI-440C stainless steel
Material (cage)	AISI-304 stainless steel
Closures	Metal shields
Load rating (stat)	9 Kgf
Load rating (dyn)	25 Kgf
Speed Limit *	60,000 rpm
Standard Lubrication **	Kyodo Yushi Multemp SRL grease

* with adequate lubrication

** may vary

These bearings comply with EU ROHS and REACH regulations.

RADIAL PLAY	MC1	MC2	MC3	MC4	MC5	MC6
(microns)	0 - 5	3 - 8	5 - 10	8 - 13	13 - 20	20 - 28

TOLERANCE	P0	P6	P5
Bore Deviation	+0 / -0.008mm	+0 / -0.007mm	+0 / -0.005mm
OD Deviation	+0 / -0.008mm	+0 / -0.007mm	+0 / -0.005mm
Width Deviation	+0 / -0.120mm	+0 / -0.120mm	+0 / -0.040mm
Bore Variation	10	9	5
OD Variation	10	9	5
Width Variation	15	15	5
Inner Radial Runout	10	6	4
Outer Radial Runout	15	8	5

SMB Bearings take no responsibility for any errors or omissions in this data sheet. We reserve the right to change specifications without prior notice. We recommend that adequate testing is carried out on products before they are determined as suitable for an application.