

# SMB Bearings

# Radial Ball Bearing

## Part Number: S6010



(for illustration only)

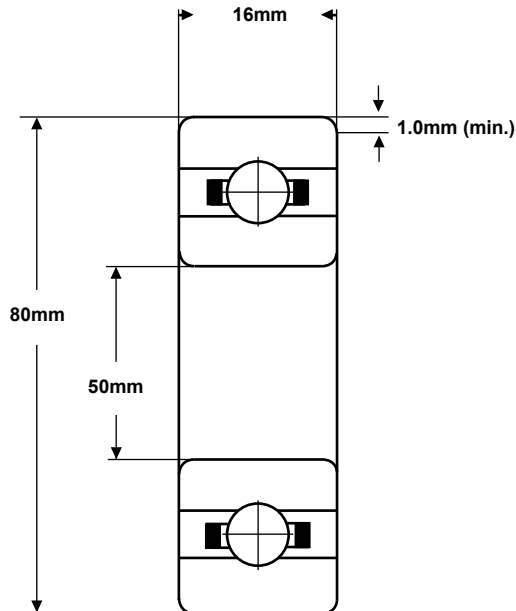

<b>Material (rings &amp; balls)</b>	KS440 / AISI-440C stainless steel
<b>Material (cage)</b>	AISI-304 stainless steel
<b>Closures</b>	None
<b>Load rating (stat)</b>	1326 Kgf
<b>Load rating (dyn)</b>	1851 Kgf
<b>Speed Limit *</b>	9,900 rpm
<b>Standard Lubrication **</b>	Aeroshell Fluid 12 oil

\* with adequate lubrication

\*\* may vary

**These bearings comply with EU ROHS and REACH regulations.**

<b>RADIAL PLAY</b>	<b>C2</b>	<b>CN</b>	<b>C3</b>	<b>C4</b>
(microns)	1 - 11	6 - 23	18 - 36	30 - 51

<b>TOLERANCE</b>	<b>P0</b>	<b>P6</b>	<b>P5</b>
<b>Bore Deviation</b>	+0 / -0.012mm	+0 / -0.010mm	+0 / -0.008mm
<b>OD Deviation</b>	+0 / -0.013mm	+0 / -0.011mm	+0 / -0.009mm
<b>Width Deviation</b>	+0 / -0.120mm	+0 / -0.120mm	+0 / -0.040mm
<b>Single Bore Variation</b>	12	10	6
<b>Single OD Variation</b>	20	16	7
<b>Inner Width Variation</b>	20	20	5
<b>Outer Width Variation</b>	20	20	5
<b>Inner Radial Runout</b>	15	10	5
<b>Outer Radial Runout</b>	25	13	8

SMB Bearings take no responsibility for any errors or omissions in this data sheet. We reserve the right to change specifications without prior notice. We recommend that adequate testing is carried out on products before they are determined as suitable for an application.