

# SMB Bearings

# Radial Ball Bearing

## Part Number: S316-6205-2PES



(for illustration only)

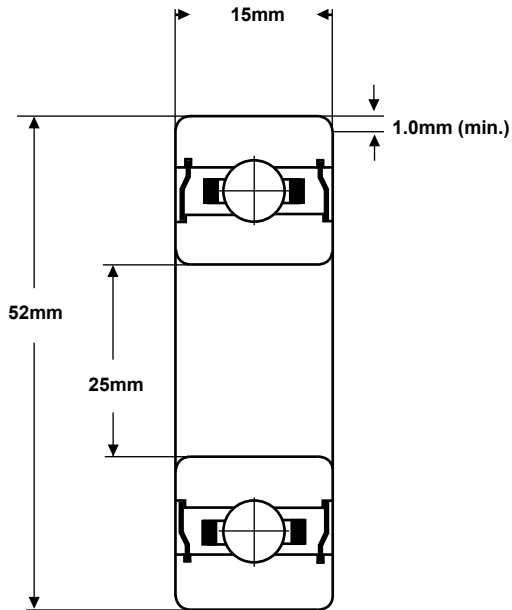

<b>Material (rings &amp; balls)</b>	AISI316 stainless steel
<b>Material (cage)</b>	PE or PEEK
<b>Closures</b>	PE or PEEK seals
<b>Load rating (stat)</b>	128 Kgf
<b>Load rating (dyn)</b>	171 Kgf
<b>Speed Limit *</b>	900 rpm
<b>Standard Lubrication **</b>	None

\* with adequate lubrication  
 \*\* may vary

**These bearings comply with EU ROHS and REACH regulations.**

<b>RADIAL PLAY</b>	<b>C2</b>	<b>CN</b>	<b>C3</b>	<b>C4</b>
(microns)	1 - 11	5 - 20	13 - 28	23 - 41

<b>TOLERANCE</b>	
<b>Bore Deviation</b>	+0 / -0.050mm
<b>OD Deviation</b>	+0 / -0.050mm
<b>Width Deviation</b>	+0 / -0.120mm

SMB Bearings take no responsibility for any errors or omissions in this data sheet. We reserve the right to change specifications without prior notice. We recommend that adequate testing is carried out on products before they are determined as suitable for an application.