

# SMB Bearings

# Radial Ball Bearing

## Part Number: F605ZZ



(not actual bearing)

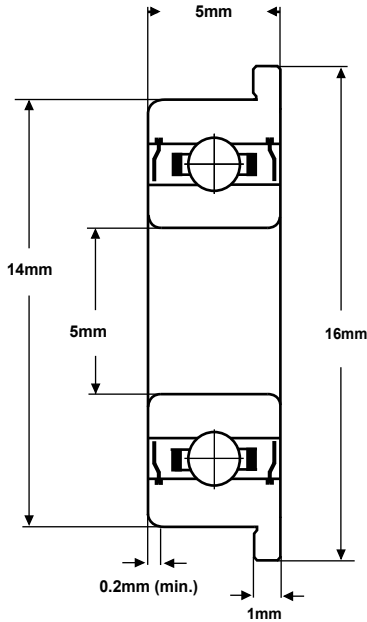

<b>Material (rings &amp; balls)</b>	SAE52100 chrome steel
<b>Material (cage)</b>	pressed steel
<b>Closures</b>	Metal shields
<b>Load rating (stat)</b>	48 Kgf
<b>Load rating (dyn)</b>	129 Kgf
<b>Speed Limit *</b>	40,000 rpm
<b>Standard Lubrication **</b>	Kyodo Yushi Multemp SRL grease

\* with adequate lubrication

\*\* may vary

**These bearings comply with EU ROHS and REACH regulations.**

RADIAL PLAY	MC1	MC2	MC3	MC4	MC5	MC6
(microns)	0 - 5	3 - 8	5 - 10	8 - 13	13 - 20	20 - 28

TOLERANCE	P0	P6	P5
<b>Bore Deviation</b>	+0 / -0.008mm	+0 / -0.007mm	+0 / -0.005mm
<b>OD Deviation</b>	+0 / -0.008mm	+0 / -0.007mm	+0 / -0.005mm
<b>Width Deviation</b>	+0 / -0.120mm	+0 / -0.120mm	+0 / -0.040mm
<b>Single Bore Variation</b>	10	9	5
<b>Single OD Variation</b>	10	9	5
<b>Inner Width Variation</b>	15	15	5
<b>Outer Width Variation</b>	15	15	5
<b>Inner Radial Runout</b>	10	6	4
<b>Outer Radial Runout</b>	15	8	5
<b>Flange OD Deviation</b>	+0.125/-0.05mm	+0.125/-0.05mm	+0 / -0.025mm
<b>Fl. Width Deviation</b>	+0 / -0.05mm	+0 / -0.05mm	+0 / -0.05mm

SMB Bearings take no responsibility for any errors or omissions in this data sheet. We reserve the right to change specifications without prior notice. We recommend that adequate testing is carried out on products before they are determined as suitable for an application.