

SMB Thrust Bearing

F4-10 (flat washers)

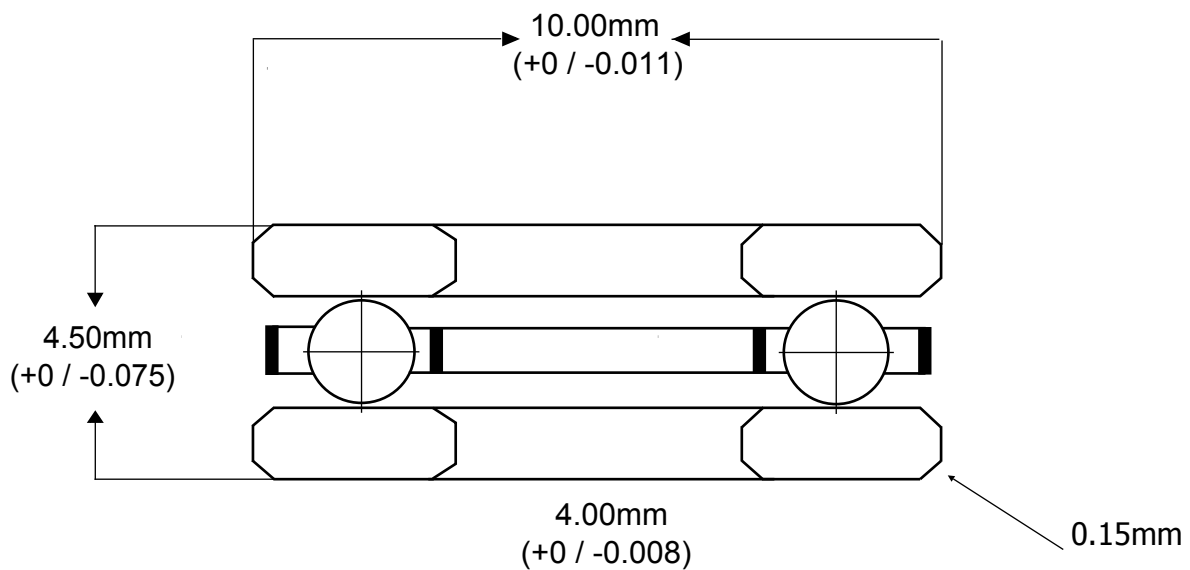

Material:

Balls & Washers:

Chrome Steel

Cage: Brass

Lubrication:

Light Oil (AF2)

Load Ratings:

36kgf (dynamic)

25kgf (static)