

SMB Bearings

Radial Ball Bearing

Part Number: CCZR-6701



(for illustration only)

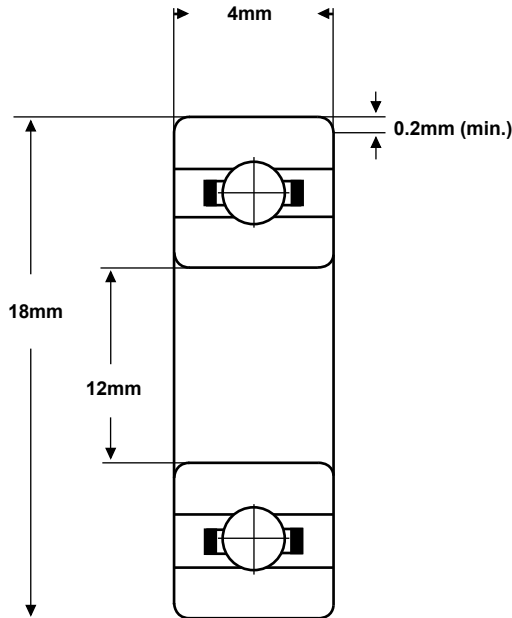

Material (rings & balls)	Zirconium dioxide (ZrO ₂)
Material (cage)	Full complement, PEEK or PTFE
Closures	None
Load rating (stat)	39 Kgf
Load rating (dyn)	69 Kgf
Speed Limit *	3,000 rpm
Standard Lubrication **	None

* with adequate lubrication
 ** may vary

These bearings comply with EU ROHS and REACH regulations.

RADIAL PLAY	C2	CN	C3	C4
(microns)	0 - 9	3 - 18	11 - 25	18 - 33

TOLERANCE	P0
Bore Deviation	+0 / -0.008mm
OD Deviation	+0 / -0.009mm
Width Deviation	+0 / -0.120mm

SMB Bearings take no responsibility for any errors or omissions in this data sheet. We reserve the right to change specifications without prior notice. We recommend that adequate testing is carried out on products before they are determined as suitable for an application.