

# SMB Bearings

# Radial Ball Bearing

## Part Number: AC6208-GL



(for illustration only)

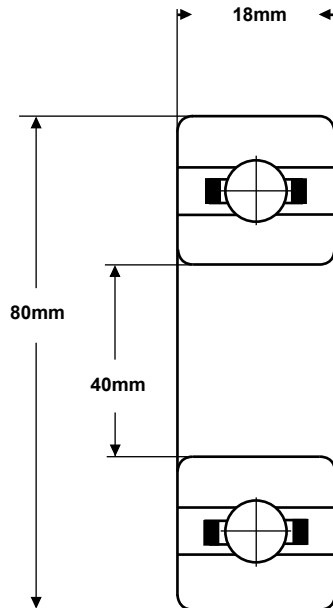

<b>Material (rings)</b>	Acetal Resin (POM)
<b>Material (balls)</b>	Glass
<b>Material (cage)</b>	PA66 Nylon
<b>Closures</b>	None
<b>Load rating (stat)</b>	40 Kgf
<b>Load rating (dyn)</b>	47 Kgf
<b>Speed Limit</b>	1,000 rpm

**These bearings comply with EU ROHS and REACH regulations.**

TOLERANCE	
<b>Bore Deviation</b>	+/-0.1mm
<b>OD Deviation</b>	+/-0.1mm
<b>Width Deviation</b>	+/-0.5mm

**\*\* Please note, plastic bearings are semi-precision**

SMB Bearings take no responsibility for any errors or omissions in this data sheet. We reserve the right to change specifications without prior notice. We recommend that adequate testing is carried out on products before they are determined as suitable for an application.