

SMB Bearings

Radial Ball Bearing

Part Number: 6915ZZ



(for illustration only)

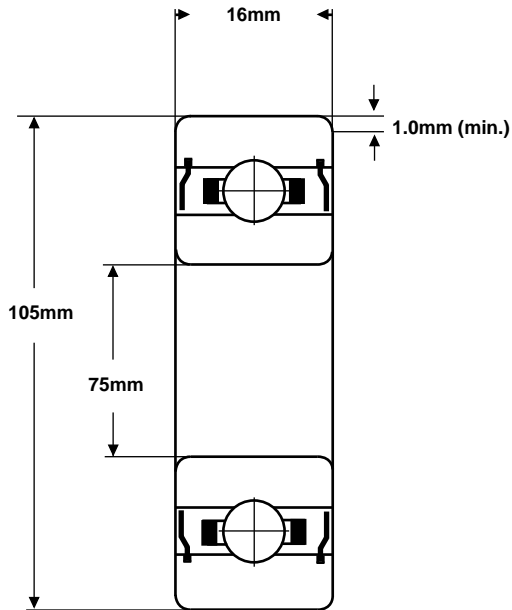

Material (rings & balls)	SAE52100 chrome steel
Material (cage)	pressed steel
Closures	Metal shields
Load rating (stat)	2260 Kgf
Load rating (dyn)	2440 Kgf
Speed Limit *	6,100 rpm
Standard Lubrication **	Kyodo Yushi Multemp SRL grease

* with adequate lubrication

** may vary

These bearings comply with EU ROHS and REACH regulations.

RADIAL PLAY	C2	CN	C3	C4
(microns)	1 - 15	10 - 30	25 - 51	46 - 71

TOLERANCE	P0	P6	P5
Bore Deviation	+0 / -0.015mm	+0 / -0.012mm	+0 / -0.009mm
OD Deviation	+0 / -0.015mm	+0 / -0.013mm	+0 / -0.010mm
Width Deviation	+0 / -0.150mm	+0 / -0.150mm	+0 / -0.150mm
Single Bore Variation	19	15	9
Single OD Variation	19	16	10
Inner Width Variation	25	25	6
Outer Width Variation	25	25	8
Inner Radial Runout	20	10	5
Outer Radial Runout	35	18	10

SMB Bearings take no responsibility for any errors or omissions in this data sheet. We reserve the right to change specifications without prior notice. We recommend that adequate testing is carried out on products before they are determined as suitable for an application.