

SMB Bearings

Radial Ball Bearing

Part Number: 1615-2RS



(for illustration only)

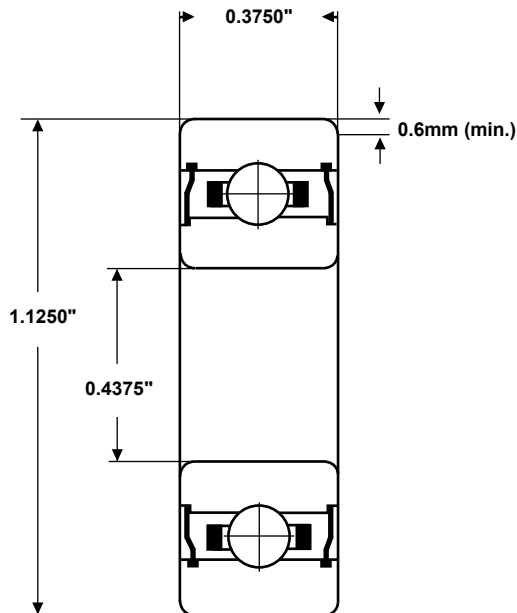

| | |
|-------------------------------------|--------------------------------|
| Material (rings & balls) | SAE52100 chrome steel |
| Material (cage) | pressed steel |
| Closures | Rubber contact seals |
| Load rating (stat) | 219 Kgf |
| Load rating (dyn) | 468 Kgf |
| Speed Limit * | 19,000 rpm |
| Standard Lubrication ** | Kyodo Yushi Multemp SRL grease |

* with adequate lubrication

** may vary

These bearings comply with EU ROHS and REACH regulations.

| RADIAL PLAY | C2 | CN | C3 | C4 |
|--------------------|-----------|-----------|-----------|-----------|
| (microns) | 0 - 9 | 3 - 18 | 11 - 25 | 18 - 33 |

| TOLERANCE | P0 | P6 | P5 |
|------------------------------|---------------|---------------|---------------|
| Bore Deviation | +0 / -0.008mm | +0 / -0.007mm | +0 / -0.005mm |
| OD Deviation | +0 / -0.009mm | +0 / -0.008mm | +0 / -0.006mm |
| Width Deviation | +0 / -0.120mm | +0 / -0.120mm | +0 / -0.080mm |
| Single Bore Variation | 8 | 7 | 4 |
| Single OD Variation | 12 | 10 | 5 |
| Inner Width Variation | 20 | 20 | 5 |
| Outer Width Variation | 20 | 20 | 5 |
| Inner Radial Runout | 10 | 7 | 4 |
| Outer Radial Runout | 15 | 9 | 6 |

SMB Bearings take no responsibility for any errors or omissions in this data sheet. We reserve the right to change specifications without prior notice. We recommend that adequate testing is carried out on products before they are determined as suitable for an application.