

SMB Bearings

Radial Ball Bearing

Part Number: 1603



for illustration only

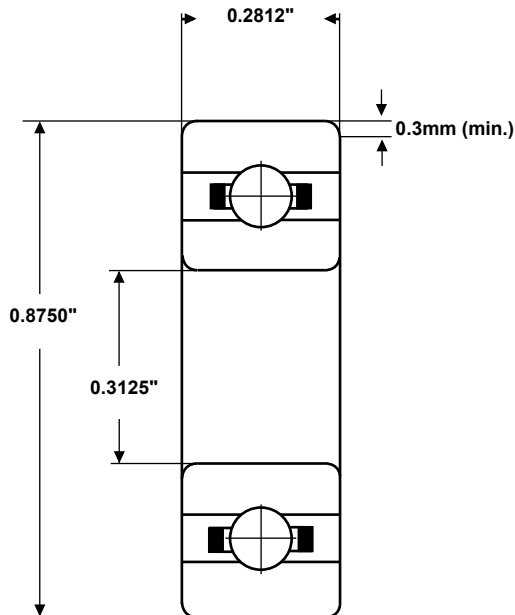

Material (rings & balls)	SAE52100 chrome steel
Material (cage)	pressed steel
Closures	None
Load rating (stat)	135 Kgf
Load rating (dyn)	317 Kgf
Speed Limit *	37,000 rpm
Standard Lubrication **	Aeroshell Fluid 12 oil

* with adequate lubrication

** may vary

These bearings comply with EU ROHS and REACH regulations.

RADIAL PLAY	MC1	MC2	MC3	MC4	MC5	MC6
(microns)	0 - 5	3 - 8	5 - 10	8 - 13	13 - 20	20 - 28

TOLERANCE	P0	P6	P5
Bore Deviation	+0 / -0.008mm	+0 / -0.007mm	+0 / -0.005mm
OD Deviation	+0 / -0.009mm	+0 / -0.008mm	+0 / -0.006mm
Width Deviation	+0 / -0.120mm	+0 / -0.120mm	+0 / -0.040mm
Single Bore Variation	8	7	4
Single OD Variation	9	8	5
Inner Width Variation	15	15	5
Outer Width Variation	15	15	5
Inner Radial Runout	10	6	4
Outer Radial Runout	15	9	6

SMB Bearings take no responsibility for any errors or omissions in this data sheet. We reserve the right to change specifications without prior notice. We recommend that adequate testing is carried out on products before they are determined as suitable for an application.